



*Horizon is the biggest graphic carrier in the range with a graphic area of up to 6m<sup>2</sup> (236.22<sup>m2</sup>) single or double sided. It's the ideal promotional solution for outdoor events, advertisements, exhibitions and public areas such as airports and shopping malls.*

*Several units can be linked together as a seamless wall to make an even bigger impact.*

### features & benefits

- Indoor or outdoor, single or double sided banner system
- Telescopic pole for adjustable graphic height up to a maximum of 2400mm approx (60.96")
- 2000mm (63.50") approx graphic width
- Individual units can be joined together
- Hollow feet for water or sand weighting for total stability
- Quick to assemble

hardware specifications	graphic specifications	additional info
<p>Hardware Dimensions</p> <p>Maximum overall height of unit: 3000mm (118.11") approx</p> <p>Base tank dimensions: 800 x 240mm (31.50 x 9.45") approx</p> <p>Weight: 13.4kg (29.54lbs) approx</p> <p>Weight does not include graphics or transit packaging</p> <p>Each base tank holds 28 Litres (7.40 US gallons) approx of water</p>	<p>Graphic Dimensions: 2000mm (h-max) to 1500mm (h-min) x 2500mm (w) approx 78.74" (h-max) to 59.05" (h-min) x 98.42" (w) approx</p> <p>Substrate: Lightweight outdoor banner material (solid or mesh type substrates) and or dye sublimated fabrics Graphic requires 20 off eyelets 9.5mm (0.37") recommended internal eyelet diameter For more details please see back page</p>	<p>Availability: Aluminium and moulded grey plastic base</p> <p>Accessories: To create a seamless wall of graphics, complete sets need to be purchased.</p>

# Assembly Instructions

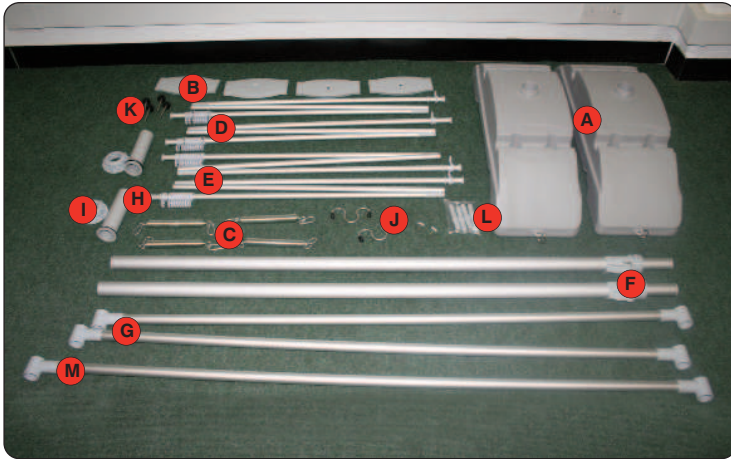

- Kit includes:
- 2 x base tanks (A)
  - 4 x base covers (B)
  - 4 x base springs (C)
  - 2 x top bungee poles (D)
  - 2 x bottom bungee poles (E)
  - 2 x telescopic support poles (F)
  - 2 x base poles (G)
  - 2 x hollow base tubes (H)
  - 2 x base screws (I)
  - 2 x graphic support hooks (J)
  - 2 x telescopic support pole screws (K)
  - 4 x spare bungee ends (L)
  - 1 x top support pole (M)

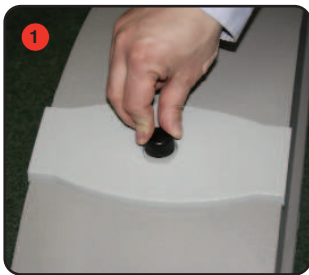

1  
Unscrew the 4 base screws from the base tanks and put to one side.



2  
Lift off the 4 base covers and put to one side.

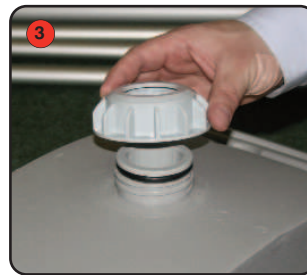

3  
Un-fasten the base screws from the base tank.

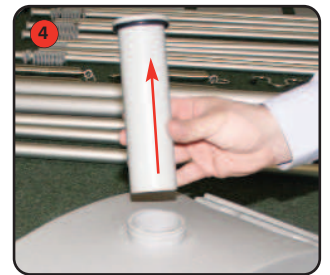

4  
Remove the base tubes from the base tank.  
Fill each tank with water or sand, then re-fit the base tubes and fasten the screws.

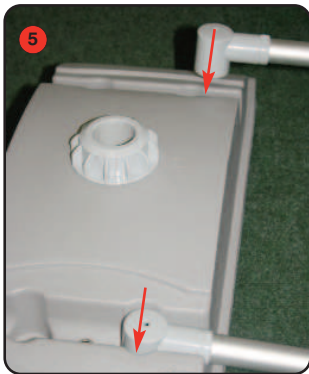

5  
Take the 2 base poles and slot into each base tank.  
Repeat for the 2nd tank.

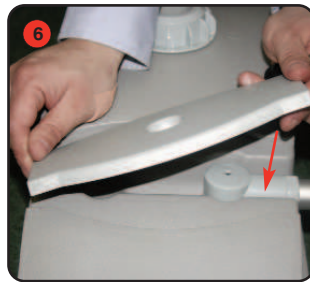

6  
Refit the 4 base covers.

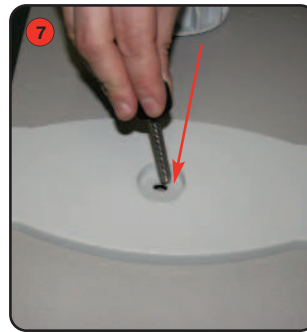

7  
Fasten the 4 base screws to secure.

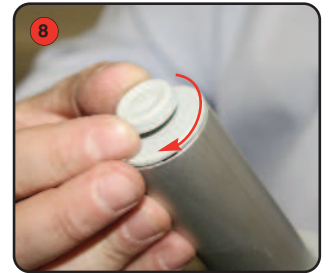

8  
Unfasten the screw from the top of each telescopic support pole and put to one side.

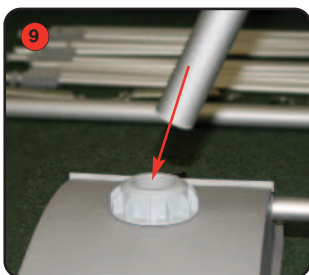

9  
Take a telescopic pole and insert into the base tank.  
Repeat for the 2nd tank.

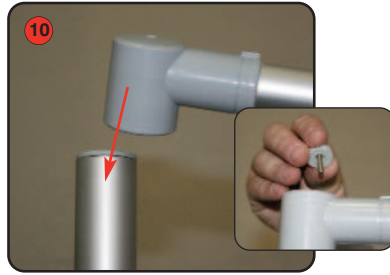

10  
Fit the top support pole over the top of each telescopic pole and secure with screws removed previously.

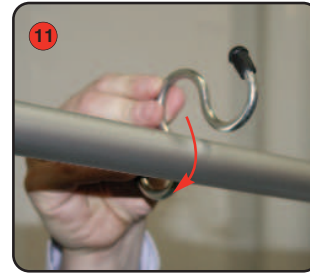

11  
Place the 2 graphic support hooks over the top support pole.

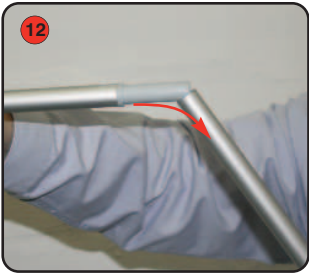

Assemble 1 top bungee pole and 1 bottom bungee pole.

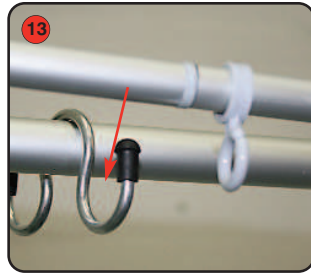

Rest the top bungee pole (pole WITHOUT metal rings) onto each support hook.

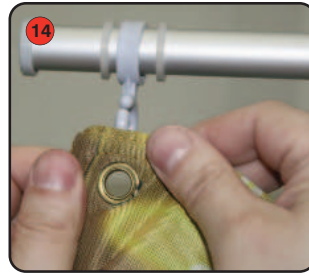

Take the top horizontal edge of the graphic and attach each eyelet onto the plastic hooks on the top bungee pole. Space out evenly.



Attach the base springs to each base tank ring.



Attach the other end of the base spring to the bottom bungee pole ring.

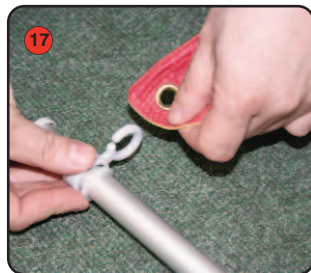

Take the bottom horizontal edge of the graphic and attach each eyelet onto the plastic hooks on the bottom bungee pole. Space out evenly. For double sided display repeat steps 14 to 17 for the 2nd graphic



Unlock one telescopic support pole and raise up the graphics to the desired height.

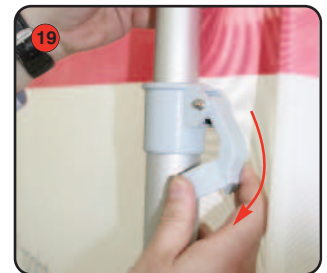

Lock the telescopic support pole into place. Repeat for the 2nd support pole.

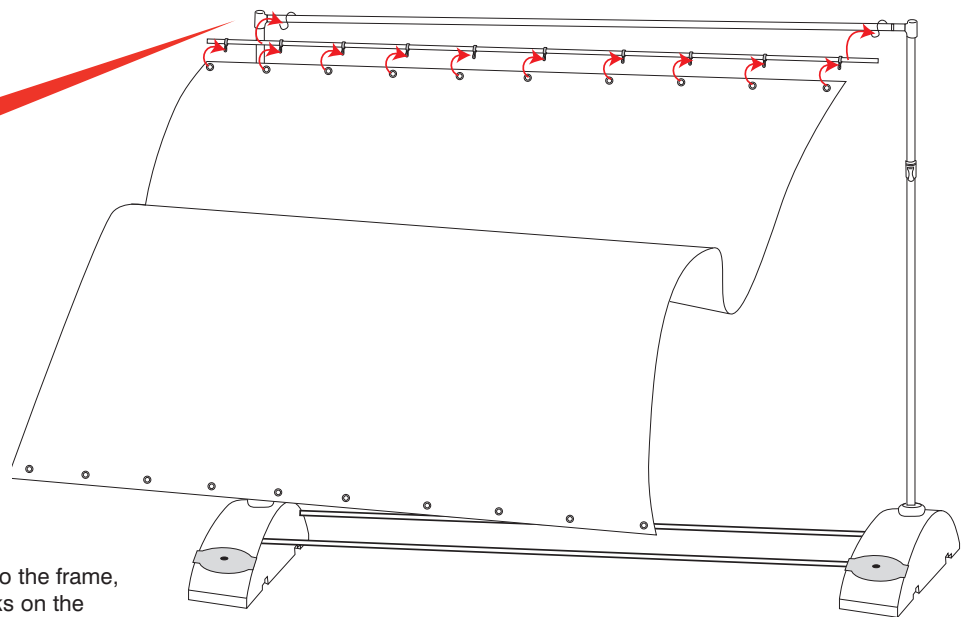
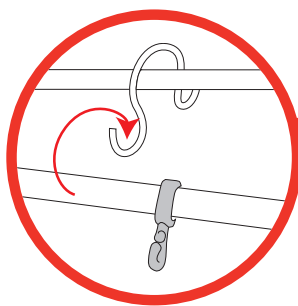
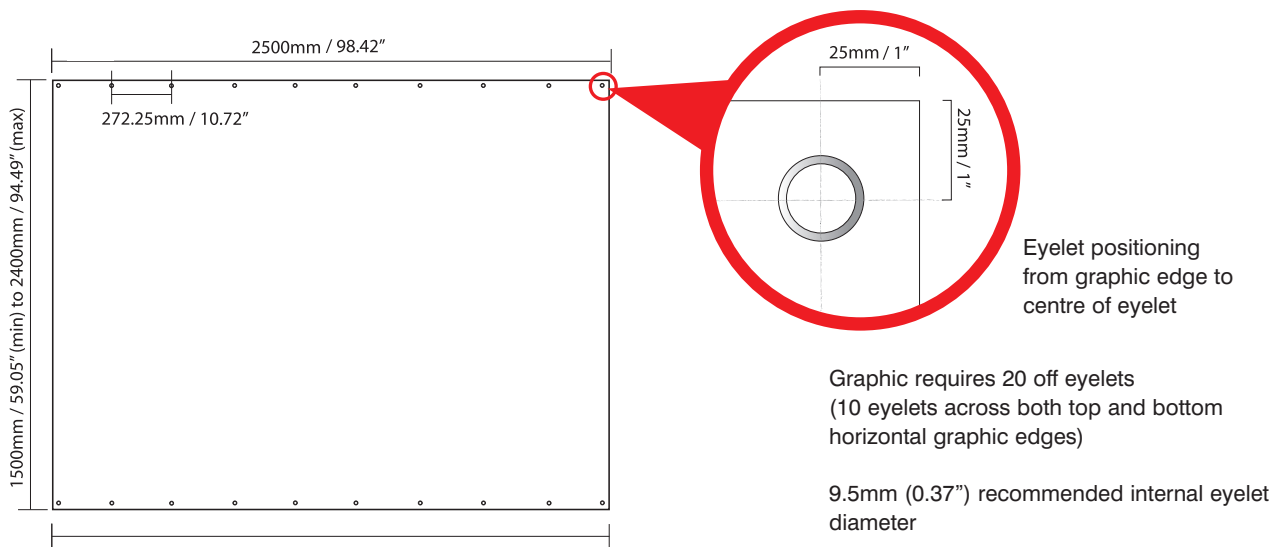
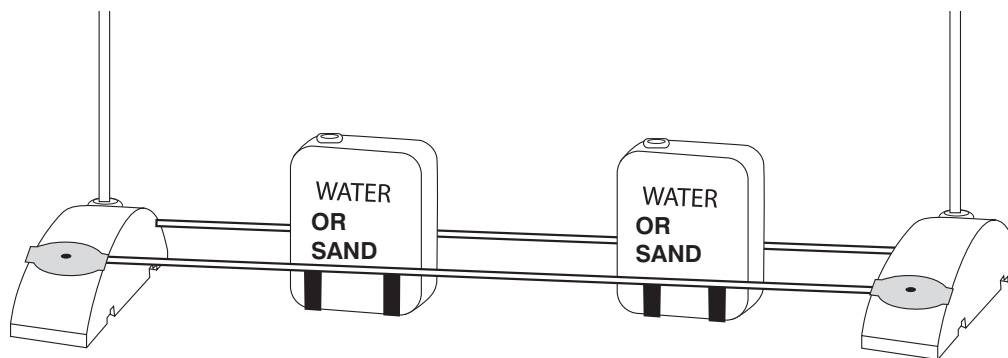

Illustration to show how graphic fits to the frame, each graphic eyelet attaches to hooks on the horizontal bungee poles.



Recommended graphic dimensions and eyelet positioning (all dimensions are approx)



Horizon is suitable for indoor or outdoor use. However if used in strong winds extra weighting may be necessary. Attach straps (not included) to the base poles to hold additional weights (not included).