

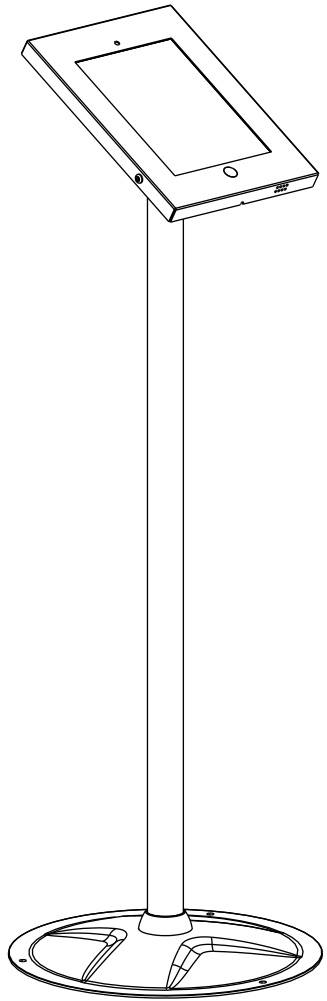

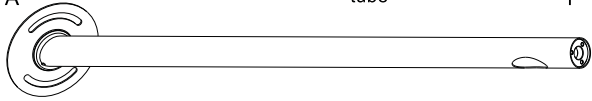











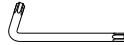
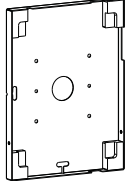

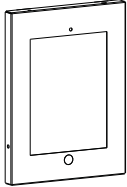
Freestanding iPad Holder



ITEM	DESCRIPTION/PART NO.	QUANTITY	ITEM	DESCRIPTION/PART NO.	QUANTITY
A	 tube	1	G	 M5x8(tamper-proof screw)	4
B	 plastic cover	1	H	 M5x20	3
C	 washer	1	I	 $\Phi 13.5 \times \Phi 5.5 \times 3.2$	2
D	 base	1	J	 TORX tool	1
E	 rear cover	1	K	 ST6.3x55	3
F	 front cover	1	L	 Concrete anchor	3
M	 silicone pad	2	N	 silicone pad	2
O	 silicone pad	1	P	 silicone pad	1
Q	 silicone pad	1	R	 silicone pad	1

Freestanding iPad Holder

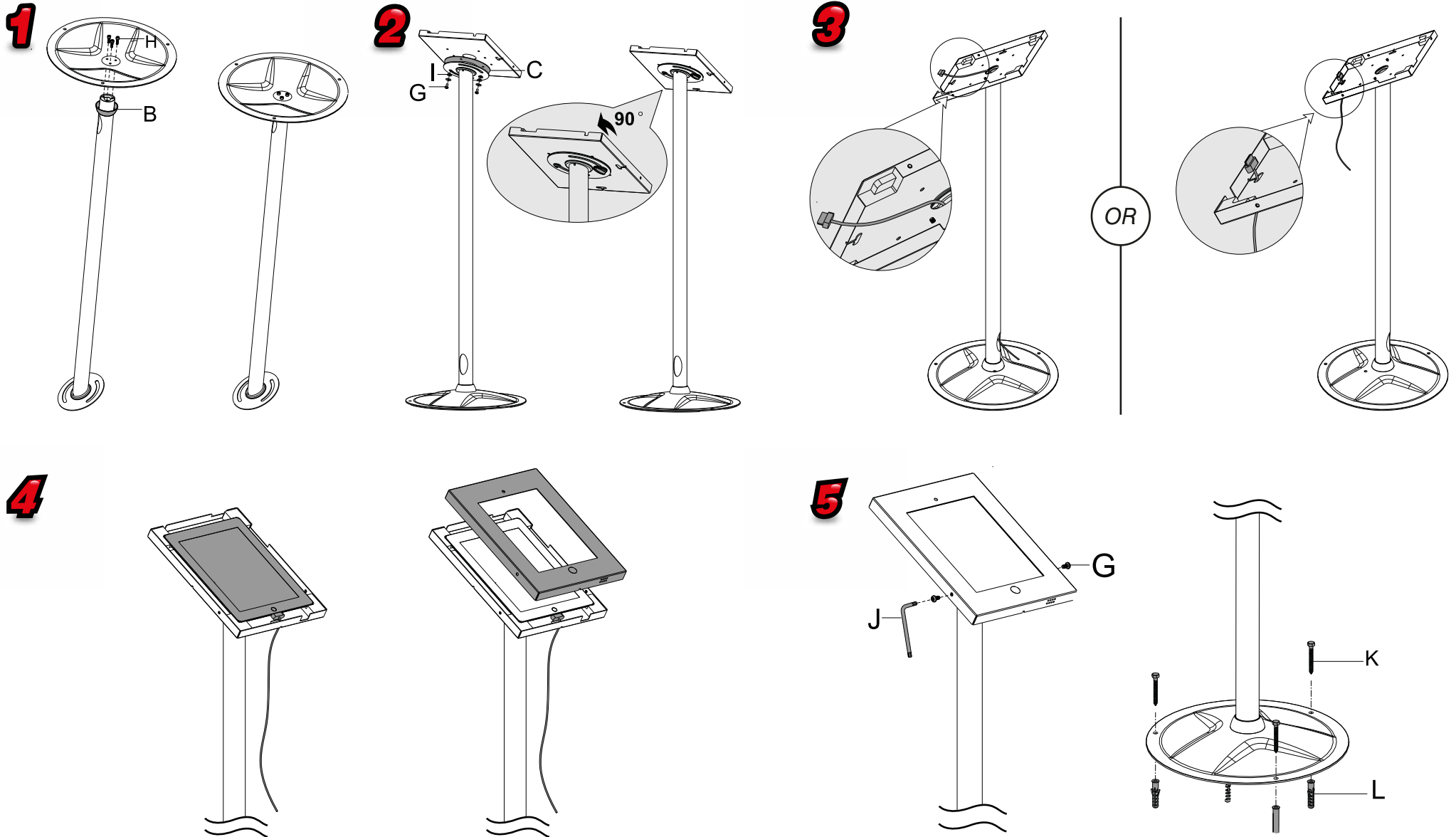

Freestanding iPad Holder

iPad Air pad fittings.

1

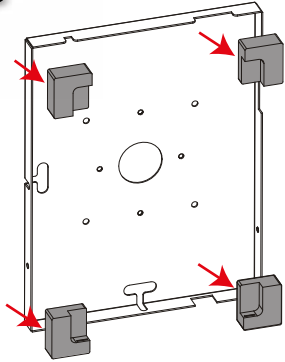

2

